



~~2021-2022~~
2023-2024

Montana Agricultural Land Classification and Valuation Manual



**Assessment
Division**

Effective January 1, 2024
2023



Department of Revenue

~~2021-2022~~ 2023-2024

Montana Agricultural Land Classification and Valuation Manual

January 1, ~~2021~~ 2023-December 31, ~~2022~~ 2024

~~State of Montana~~

~~Greg Gianforte, Governor~~

~~Montana Department of Revenue~~

~~Brendan Beatty, Director~~

Compiled By

Property Assessment Division

~~Kory Hofland, Administrator~~

~~Donovan Building~~

~~340 N. Last Chance Gulch~~

~~PO Box 8018~~

~~Helena, Montana 59601~~

~~The Department of Revenue prepared the Montana Agricultural Land Classification Manual (manual) pursuant to~~
~~[15-7-201, MCA](#).~~

~~The manual is available to the general public.~~

~~Please direct questions pertaining to this document to the Department of Revenue Property Assessment Division at~~
~~<https://mtrevenue.gov>~~

Contents

Introduction 1

Appraiser Certification 1

History 1 2

The State Constitution 1 2

2009 Reappraisal..... 2

GIS.....2

Phase-In.....2 3

Statutes and Administrative Rules 3

~~Agricultural Property Valuation Laws.....3~~

~~Agricultural Property Valuation Laws.....3~~

Ownerships..... 5 4

Easements and Deeded Right-of-Ways 5 4

Conservation Easements 6 4

Land Taken for a Public Use 6 5

Water Boundaries 7 5

Island Ownership in Rivers 7 6

Contiguous vs. Noncontiguous Parcels 7 6

Appraisal Process 10 9

Productivity 12 10

Soil Surveys 12 10

General Productivity Determination Information 13 11

Non-Irrigated Farmland 14 12

Non-Irrigated Continuously Cropped Hay Land 15 13

Irrigated Farm Land 16 14

Grazing Land 17 15

Carrying Capacity Expressions 18 16

Animal Units (AU) 18 16

Animal Unit Months (AUM)..... 18 16

Animal Unit Months/Acre (AUM/Ac) 19 17

Acres/Animal Unit Month (Ac/AUM) 19 17

Calculating Carrying Capacity 19 17

Agricultural Eligibility 22 20

Eligibility Requirements	23 <u>21</u>
Income Sources	24 <u>22</u>
Ownerships less than <u>Less Than 20 acres</u> <u>Acres in size</u> <u>Size</u>	24 <u>22</u>
Ownerships 20 Acres to Less Than 160 Acres in Size	24 <u>22</u>
Contiguous Ownerships 160 Acres or Greater in Size	25 <u>23</u>
Noncontiguous Parcels in the Same <u>Under One</u> <u>Ownership</u>	25 <u>23</u>
Exceptions to the \$1,500 Income Requirement	25 <u>23</u>
Consumption of products <u>Products</u>	25 <u>23</u>
Grazing land requirement <u>Land Requirement</u>	25 <u>24</u>
Production Failure or Marketing Delay	26 <u>24</u>
Family Relationships	26 <u>24</u>
<u>Provisional classification with ownership transfer</u>	<u>24</u>
Classification.....	27 <u>25</u>
Non-irrigated Summer Fallow Farm Land	28 <u>26</u>
Non-irrigated Continuously Cropped Farm Land	29 <u>27</u>
Non-irrigated Continuously Cropped Hay Land	29 <u>27</u>
Irrigated Farmland	29 <u>27</u>
Grazing Land	30 <u>28</u>
Agricultural Valuation	30 <u>28</u>
Commodity Price information	31 <u>29</u>
Base Crops	31 <u>29</u>
Crop Share	31 <u>29</u>
Gross and Net Income	32 <u>30</u>
Capitalization Rate	32 <u>30</u>
Irrigated Land Valuation	33 <u>31</u>
Minimum Value of Irrigated Land	33 <u>31</u>
Specialty Crops	34 <u>31</u>
Nonqualified Agricultural Land	34 <u>32</u>
Nonproductive Patented Mining Claims	34 <u>32</u>
Homesites.....	35 <u>33</u>
Cadastral Information	42 <u>39</u>
Montana Cadastral Map	42 <u>39</u>
Geographic Information System (GIS).....	43 <u>39</u>

Important Dates	43 <u>40</u>
Appraisal Date	43 <u>40</u>
Classification and Appraisal Notice	43 <u>40</u>
Application for Agricultural Classification	44 <u>40</u>
Addendum <u>Appendix A</u>	Error!
Bookmark not defined. <u>41</u>	
<u>Appendix B</u>	<u>43</u>

Introduction

Agriculture is the science, art, or occupation of cultivating land, raising crops, and feeding, breeding, and raising livestock. American Heritage dictionary of the English language, Fifth Edition. It is also referred to as farming or ranching. The term 'agricultural' means the production of food, feed, livestock, poultry, bees, biological control insects, fruits, and vegetables, as well as sod, ornamental, nursery, horticultural crops, and fiber commodities that are raised, grown, or produced for commercial purposes. It also includes the raising of domestic animals and wildlife in domestication or a captive environment. [15-1-101, MCA](#).

In Montana, the term 'livestock' includes typical domesticated animals: cattle, sheep, swine, goats, horses, mules, and asses. In addition, it also includes "llamas, alpacas, bison, ostriches, rheas, emus, and others." [15-1-101, MCA](#) and [ARM 42.20.601](#).

Agricultural land is land that meets the eligibility requirements for agricultural classification found in the eligibility section of this manual. Valuation of agricultural land in Montana is based on value in use. This means that value is based on the capability of the land to raise a specific base crop.

Appraiser Certification

~~The department offers trains its agricultural appraisers through an Agricultural Land Classification/ and Appraisal (ALCA) class to provide employees with appraisal training for valuing Montana's agricultural properties. Authority and responsibility for this task is set out in Montana Code Annotated (MCA). The Administrative Rules of Montana (ARM) further define the process for certification criteria. The prerequisite for an agricultural appraiser includes department certification as a residential appraiser, as set in, ARM 42.18.207 and 15-7-102, MCA. Further certification requirements include: Agricultural appraisers must complete: certification as a residential appraiser, complete ALCA training; pass the ALCA exam; and complete a one-year apprenticeship under a department certified agricultural appraiser.~~

- ~~1) Attend and complete ALCA training;~~
- ~~2) Pass the corresponding ALCA exam; and~~
- ~~3) Complete one year of agricultural appraisal duties on the job.~~

History

Early taxation of property in Montana began before statehood. In 1919, a separate tax class was developed to classify various lands including irrigated, non-irrigated tillable, grazing, timber, cutover, and mineral lands.

The State Constitution

In 1972, Montana adopted a new Constitution that abolished the Board of Equalization and turned the responsibility of assessing property over to the department.

In 1973, the Montana Legislature passed several statutes pertaining to the valuation of agricultural land. That same year, the department adopted administrative rules and guidelines relating to the valuation of agricultural land including assignment of productivity grades.

In September 1990, the Governor appointed the first Agricultural Advisory Committee. The committee reviewed their legislative mandate, evaluated agricultural income and expense data, and recommended new valuation schedules for assessing agricultural land. Governor appointments for members to this committee are for a four-year term.

2009 Reappraisal

For the 2009 appraisal cycle, the department conducted a comprehensive classification project to value agricultural lands. This statewide reappraisal project was endorsed by the agricultural advisory committees of 2006 and 2008 as well as the legislature in 2005 and 2007.

Geographic Information System (GIS) technology linked aerial imagery with cadastral (ownership) data. This information was combined with agricultural uses obtained from the USDA Farm Services Agency. Then it was linked with soils productivity estimates for each agricultural land use based upon statewide soil survey information from the USDA Natural Resources Conservation Service (NRCS) to create productivity maps.

The department mailed out individual parcel maps for verification by the agricultural landowners statewide. Landowners were given the opportunity to update those maps. The maps showed current agricultural land uses as well as the land's productivity information and ownership.

GIS

Reappraisal activities associated with agricultural and forest lands included the use of the most recent aerial photography along with older imagery to discover changes in agriculture classification. The imagery used was from the National Agriculture Imagery Program (NAIP), a nationwide program, administered by the Department of Agriculture Farm Service Agency (FSA) Aerial Photography Field Office in Salt Lake City. The FSA has collected NAIP imagery in Montana every 2 years since 2005. These NAIP imagery datasets were available for agricultural appraisal activities in the department's agricultural/land and forest land ~~Are~~ maps for each county. The department updates these maps annually after assessments are completed to maintain appraisal data and equalize valuation statewide.

Phase-In

As of 2015, agricultural land is reappraised every two years. [15-7-111, MCA](#). Previous to 2015, valuation cycles were six years in length with large changes in value possibly occurring at the onset of a new cycle. The legislature attempted to mitigate these increases between cycles by phasing in increased property values.

For Class 3 (agricultural), Class 4 (residential, commercial, industrial), and Class 10 (forest) properties, increases in assessed values were phased-in incrementally over the six years of the reappraisal cycle resulting with the property reaching its full market value in the sixth year. The difference in value from the previous cycle was added to the

previous value in 1/6 increments each year of the cycle. Any assessed value that decreased from one reappraisal cycle to the next was fully implemented the first year of the new reappraisal cycle.

Agricultural land with productivity only changes used the previous cycle value to determine the amount of value change. Those properties with land use changes or size changes used a calculated value before reappraisal (VBR) to determine the difference in value. A VBR was the full reappraisal value from the previous appraisal cycle. A calculated VBR was electronically calculated by using the current property data (land use, size, and productivity) in the previous cycle calculations.

Statutes and Administrative Rules

The department classifies and values more than 50 million acres of privately-owned agricultural land in Montana. Montana Code Annotated, Title 15, contains the statutes regarding the appraisal and classification of agricultural land.

Montana law currently requires the department to value all agricultural property once every two years, [15-7-111, MCA](#). The department values agricultural property based on its productivity using a productivity valuation formula. The productivity valuation formula will be discussed in detail later in the manual. All agricultural land is placed in one of five sub-classes:

1. Non-irrigated summer fallow farm land
2. Non-irrigated continuously cropped farm land
3. Irrigated land
4. Grazing land
5. Continuously cropped hay land

The department is charged with the general administration and supervision of assessment laws. The department must assure that all property assessments comply with the law, are fair and equitable, and accurately represent value. [15-1-201, MCA](#).

The department must maintain current classification of all taxable lands. [15-7-101, MCA](#).

The department is also required to set and maintain uniform and equitable procedures for reclassification. [15-7-103, MCA](#).

The department uses the same agricultural appraisal methods and assessments statewide. This provides equalization across the state, [15-7-112, MCA](#), with similar properties having substantially equal taxable values.

Agricultural Property Valuation Laws

~~Below are the statutes that the department follows in appraising agricultural properties:~~

~~— 15-1-101 — Definitions~~

~~— 15-1-201 — Administration of revenue laws~~

~~— 15-6-133 — Class three property — description — taxable percentage~~

- ~~15-6-134~~ — Class four property — description — taxable percentage
- ~~15-6-201~~ — Exempt categories
- ~~15-6-207~~ — Agricultural producer exemption — low value buildings, implements, and machinery
- ~~15-7-101~~ — Classification and appraisal — duties of the department of revenue
- ~~15-7-102~~ — Notice of classification and appraisal to owners appeals
- ~~15-7-103~~ — Classification and appraisal — general and uniform methods
- ~~15-7-107~~ — Certification required
- ~~15-7-108~~ — Land split
- ~~15-7-111~~ — Periodic revaluation of certain taxable property
- ~~15-7-112~~ — Equalization of valuations
- ~~15-7-201~~ — Legislative intent — value of agricultural property
- ~~15-7-202~~ — Eligibility of land for valuation as agricultural
- ~~15-7-203~~ — Agricultural uses only considered in valuation
- ~~15-7-206~~ — Improvements on agricultural land
- ~~15-7-207~~ — Continuance of valuation as agricultural land
- ~~15-7-208~~ — Reclassification by department
- ~~15-7-210~~ — Tax on change of use of part of tract
- ~~15-7-212~~ — Tract crossing county line whole
- ~~15-8-111~~ — Assessment — market value standard exceptions
- ~~15-8-201~~ — General assessment day
- ~~15-8-307~~ — Land assessment
- ~~76-6-208~~ — Taxation of property subject to conservation easement

~~Agricultural Property Valuation Administrative Rules~~

~~The department follows these rules in appraising agricultural properties:~~

- ~~42.20.156~~ — Land Classification Change Criteria
- ~~42.20.301~~ — Application for Classification as Nonproductive, Patented Mining Claim
- ~~42.20.302~~ — Definitions (*mining claims*)
- ~~42.20.303~~ — Criteria for Valuation as Mining Claim
- ~~42.20.304~~ — Additional Restrictions That Curtail Preferential Treatment
- ~~42.20.305~~ — Valuation of Acreage Beneath Improvements on Eligible Mining Claims

- ~~— 42.20.307 — Valuation of Eligible Mining Claim Land~~
- ~~— 42.20.601 — Definitions~~
- ~~— 42.20.602 — Steps in Determining the Classification of Agricultural Land~~
- ~~— 42.20.603 — Valuation of Agricultural Land That Does Not Have A Published Soil Survey~~
- ~~— 42.20.604 — Steps in Determining the Productivity of Agricultural Land~~
- ~~— 42.20.610 — Classification of Easements on Agricultural Land~~
- ~~— 42.20.620 — Application and Classification Requirements for Agricultural Land Totaling Less Than 160 Acres in Size~~
- ~~— 42.20.640 — Classification of Land 160 Acres or Larger in Size~~
- ~~— 42.20.645 — Classification and Assessment of Those Portions of Any Agricultural, Nonqualified Agricultural, or Forest Land Parcels That Are Residential, Commercial, or Industrial Sites~~
- ~~— 42.20.650 — Valuation of Nonqualified agricultural land from 20 to 160 acres~~
- ~~— 42.20.655 — Classification and Valuation of One-Acre Beneath Residences on Agricultural and Nonqualified Agricultural Land~~
- ~~— 42.20.675 — Irrigated Agricultural Farm Land Valuation~~
- ~~— 42.20.676 — Non-Irrigated Agricultural Land Valuation~~
- ~~— 42.20.681 — Agricultural Commodity Prices and Values~~
- ~~— 42.20.682 — Family Farm Requirements for Agricultural Land Classification~~
- ~~— 42.20.683 — Specialty and Unique Crops; Additional Requirements for Agricultural Land Classification~~

Ownerships

Eligibility for agricultural classification is based on ownership of the parcel(s). Ownership is defined by the International Association of Assessing Officers (IAAO) as the rights to use the property, to the exclusion of others. Fee simple ownership includes all the rights and interests in the property except the governmental rights such as taxation, eminent domain, police power, and escheat.

Easements and Deeded Right-of-Ways

An easement is a property right held by one party to use specific land owned by another party and entitles its holder to a specific limited use or enjoyment. An easement may be created and held by either private or public entities. The easement may be temporary or held in perpetuity.

Easements are not specifically addressed in the agricultural valuation statutes.

Easements that do not transfer title are taxable to the owner of record. For example, roads, irrigation ditches, or power line easements without a recorded title transfer are

taxable and are valued according to the productivity of the underlying soils. [15-7-206, MCA](#).

A deeded right-of-way is conveyed through a deed or other instrument. A record of the ownership conveyance must be available in the local county clerk and recorder's office. An example of a deeded right-of-way is a state highway. These conveyances, often done without a survey defining boundaries, state the number of acres in the right-of-way. In these cases, the right-of-way acreage is placed into a right-of-way classification on the parcel record. When a survey defines the boundaries, the right-of-way acreage is deducted from the original ownership and placed into a right-of-way parcel. If the deeded right-of-way acres originally come from two ownerships, the department allocates equal amounts of acreage from both ownerships into the right-of-way. [ARM 42.20.610](#).

Conservation Easements

A conservation easement is a voluntary agreement between a private landowner and a land trust agency, either private or public, which establishes the acceptable use, including development rights associated with privately owned land. A conservation easement is an acquisition interest in land less than fee resulting in the transfer of ownership rights, interests, and benefits for conservation purposes, by limiting or prohibiting one or more specific uses listed in [76-6-203, MCA](#). The deed for a conservation easement gives the oversight of the land's use to a governmental agency or a private non-profit conservation organization and limits the rights of subsequent property owners. In Montana, the easement may be in perpetuity or for a term of at least 15 years.

The Montana Open-Space Land and Voluntary Conservation Easement Act, adopted in 1975, provides that no property tax advantages are granted due to the establishment of a conservation easement. The land must be classified based on the restricted uses permitted by the easement. But this classification, if it is only because of the creation of the conservation easement, cannot result in a property valuation lower than it had prior to the easement. This means Class 4 property cannot be reclassified as Class 3 or Class 10 merely because the property is placed into a conservation easement.

For example, a landowner that places a conservation easement on a parcel of tract land cannot be reclassified to Class 3-agricultural land, merely because of the easement. The property must still meet agricultural eligibility requirements.

Although rare, a conservation easement may cause a property classification change if the easement prohibits agricultural use in its entirety. [ARM 42.20.156](#).

If the conservation easement is properly renewed within 15 days of its expiration, the department will not reclassify the land. [76-6-208, MCA](#). The department's GIS staff verifies and updates data in the CAMA system, maps the conservation easement, adds it into the statewide GIS layer, and delivers this data to the state library.

Land taken for a Public Use

Land classified as agricultural land that has been reduced in size for a public use will not lose its agricultural classification due to the reduction, [15-7-202, MCA](#). An example is a 20-acre parcel of land classified as nonqualified agricultural land is reduced to 18 acres to

allow the widening of a state highway. This parcel continues to be classified as nonqualified agricultural land. Public uses are described in [70-30-102, MCA](#).

Water Boundaries

Private ownership boundaries described by a non-navigable stream, river, lake, or pond are set at the midpoint or thread of the stream. Private ownership boundaries that follow a navigable stream, river, lake, or pond are along the high-water mark of the stream bed, river, or lake, or pond. Private ownership boundaries that follow an easement such as a road also go to the centerline of the easement, unless stated differently in the deed.

In some cases, the centerline or midline of a river or stream denotes a county boundary. If the river or stream channel meanders from year to year, the county boundary does not change with the alteration of the centerline or midline.

Ownership boundaries may change due to alterations in a stream or riverbed. When the stream deposits silts and soils, a slow, imperceptible growth called accretion takes place. Under Montana law, accreted land belongs to the owner of the property benefiting from the accretion. [70-18-201, MCA](#).

The department must have validation from a court to change ownership boundaries or taxable acreage due to any of these circumstances. This ensures that the boundary change is valid and avoids litigation of ownership boundaries.

Island Ownership in Rivers

Islands located in navigable streams belong to the state unless a private party holds the title. This includes abandoned stream beds of navigable streams and lakes, all islands in these streams that have not been surveyed, and any lands that were previously a part of an island in a navigable stream or lake. [70-18-203, MCA](#).

Islands located in unnavigable streams belong to the property owner that owns that side of the stream. If the island straddles the centerline of the stream, the island ownership boundary is divided by a continuation of the stream center line. [70-18-204, MCA](#). When a stream cuts a new channel and forms an island, the land remains in the same ownership as it was prior to becoming an island. [70-18-205, MCA](#).

Ownership of an island created by accretion is given to the state if the following steps are taken.

1. The state claimed ownership by filing quiet title.
2. The court awarded the ownership to the state.

Contiguous vs. Noncontiguous Parcels

In order to determine the amount of land attributable to one owner, one must understand the concepts of contiguous and noncontiguous. The department criteria for contiguous parcels is that the parcels must be in identical ownership and share a common boundary. Contiguous parcels can be separated by the following:

1. rivers and streams;
2. deeded roads and highways;

3. railroad lines; or
4. federal or state land that is leased from the federal or state government by the owner whose land is physically touching the federal or state land.

All land in the same legally defined parcel is contiguous in ownership. In other words, a parcel may include man-made features such as easements and county boundaries, or natural features such as streams, and still be contiguous. [ARM 42.20.601](#).

The following examples demonstrate the concepts of contiguous and noncontiguous parcels.

Example 1

A landowner owns two, 10-acre tracts of land. A highway is located between these two tracts.

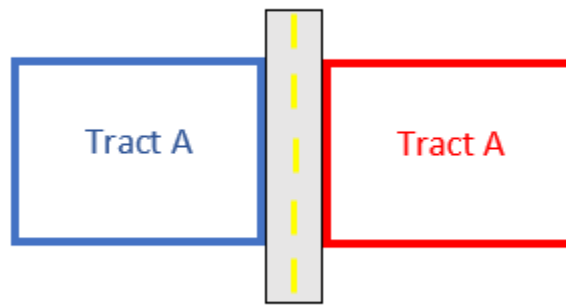

1. Both parcels are in the same ownership.
2. The parcels would touch if not separated by the highway.

These parcels are contiguous and in one ownership for the entire 20 acres.

Example 2

A landowner owns two, 10-acre tracts of land in the same ownership. The Missouri River separates the two tracts. One tract is in Cascade County and the other tract is in Chouteau County.

1. Both parcels are in the same ownership.
2. The parcels would touch if not separated by the river.

The parcels are contiguous, and the landowner's total ownership is 20 acres in size.

Example 3

A landowner owns two, 80-acre parcels of land. The parcels are separated from each other by a state section of land. The landowner leases the section of land from the State of Montana.

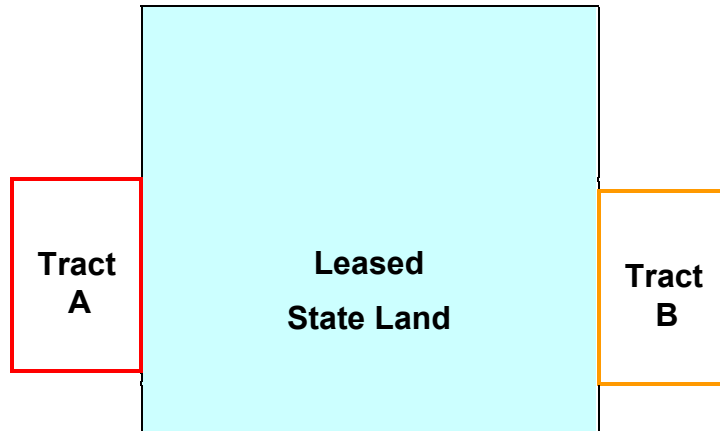

1. Both parcels are in the same ownership.
2. The parcels would touch if not separated by the government land which is leased by the landowner of Tracts A and B

Tracts A and B are contiguous, so the landowner's contiguous ownership is 160 acres in size.

Example 4

A landowner owns two, 10-acre tracts of land. The tracts touch each other at one corner.

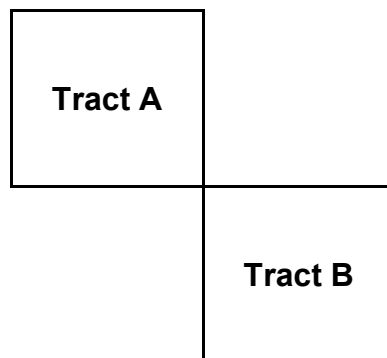

1. Both parcels are in the same ownership.
2. The parcels touch each other.

The parcels are contiguous making the landowner's contiguous ownership 20 acres in size.

Example 5

John Doe owns Tract A and Tract C. John Doe's wife, Mary Doe owns Tract B.

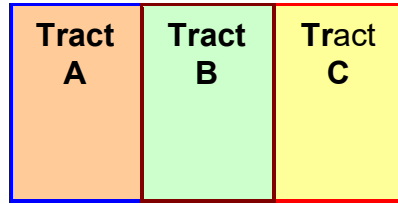

1. Joe Doe is one ownership for parcels A and C.
2. Mary Doe is a different ownership for parcel B.

Tract A and Tract C, owned by John Doe, are noncontiguous to each other.

Appraisal Process

Maintenance of the classification and productivity information on agricultural land is an on-going process involving appraiser input and review as well as the department's GIS.

Staff classifies land according to its use. Montana's land classifications include:

1. class three agricultural land;
2. class three patented nonproductive mining claims;
3. class three nonqualified agricultural land;
4. class four land; and
5. class ten forest land.

The department proposes to remove upper illustration and add lower illustration.

Does Land meet Classification Requirements?

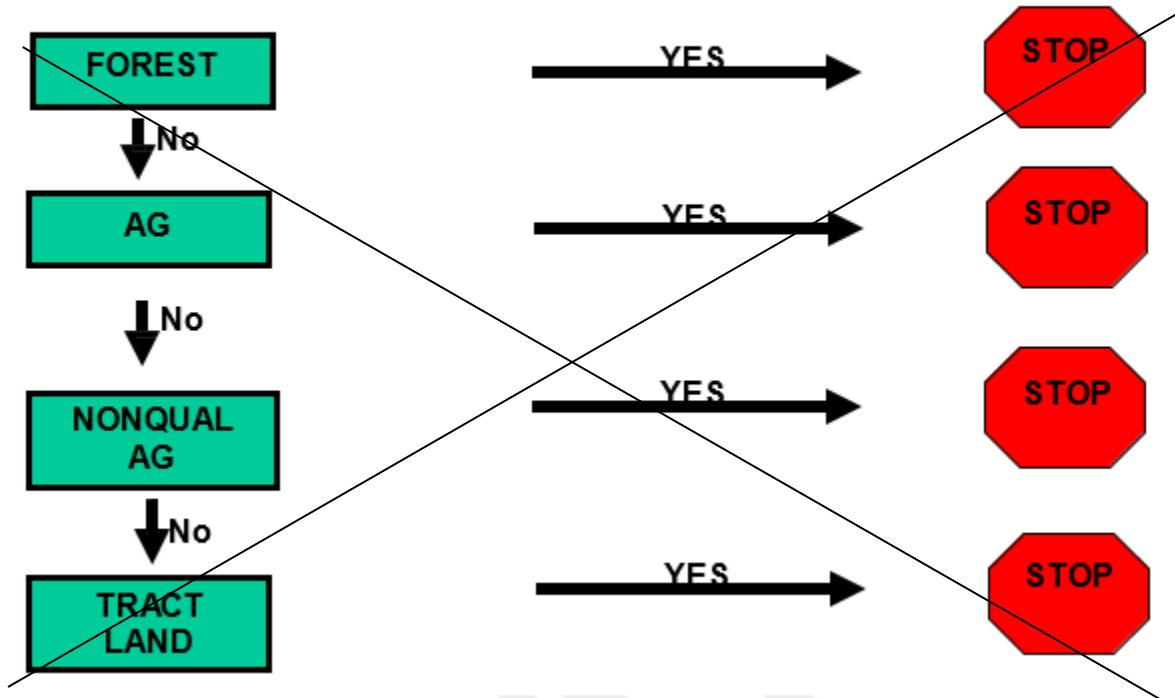

Does Land meet Classification Requirements?

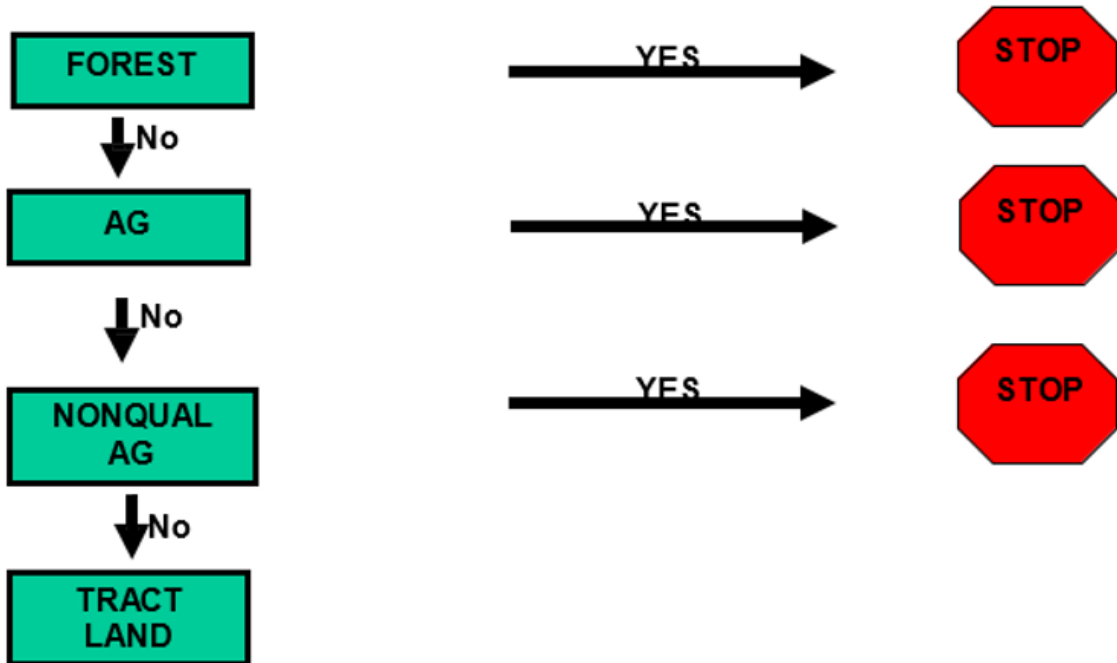

When agricultural land use changes occur, an appraiser must review information provided by the landowner and aerial photos and identify the field boundaries associated with each land use.

The appraiser must identify the following agricultural classifications ~~on the map~~:

- F ~~f~~or non-irrigated summer fallow farm land;
- C ~~f~~or non-irrigated continuously cropped farm land;
- I ~~f~~or irrigated land;
- G ~~f~~or grazing land;
- H ~~f~~or continuously cropped hay land; and
- S ~~f~~or specialty crop.

Productivity

The department appraises agricultural land based on its productivity. 15-7-201, MCA. The department determines each soil's productive capacity or ability to produce crops or produce forage to sustain livestock. ~~The department refers to this as the productive capacity or the soil's ability to produce forage~~ in the specific environment of the subject location under typical management. Productivity is determined based on the characteristics of each soil.

Prior to the 2009 reappraisal, productivity of agricultural land was rated using a grade. Each grade represented a range of productivity for that agricultural use. A statewide comprehensive review of productivity grades had not occurred since the mid 1970's or earlier. Beginning with the 2009 reappraisal, the department began determining the productivity of all agricultural land using the NRCS soil survey. 15-7-201, MCA.

Soil Surveys

A soil survey is a scientifically based detailed analysis and report of the characteristics and properties of the different components of the soils within a given area. A uniform and consistent system for determining soil productivity requires a strict set of procedures. Those procedures are defined and detailed in the NRCS Land Capability Classification System.

The information for determining agricultural land productivity are the soil map and the tabular data containing estimated crop yields of grain and alfalfa hay, estimated carrying capacity for irrigated and non-irrigated domestic pastures, and forage production on native, non-irrigated rangeland.

The productivity information is based on a high level of management and ~~an~~ ideal climatic or environmental conditions while the department is required to determine the agricultural income based on the production of a typical Montana farm or ranch. As a result, most productivity estimates from the soil survey are adjusted.

Individual soil surveys are normally limited to one county. Updated soil surveys can be located at <https://websoilsurvey.sc.egov.usda.gov/App/WebSoilSurvey.aspx>.

Changes in agricultural technology and management have generally increased crop yields over the last 30 to 40 years. Higher production levels may be the result of more efficient farm machinery and improved farming techniques such as crop rotation, fertilization, and irrigation. In addition, advanced pesticides and herbicides have helped to increase crop yields.

Soils, the basis of production, are a product of climate, living organisms and parent material. Soils consist of water, air, and solid material, including sand, silts, and clays. Soil materials are arranged in layers called soil horizons. The collective sequence of soil horizons is called a soil profile.

Soils high in soluble salts such as sodium chloride, magnesium sulfate and calcium chloride, are referred to as saline soils. Soils high in sodium are referred to as sodic soils. Saline and sodic soils have poor physical condition, high pH and are difficult to manage.

Topography, slope and aspect, influences soil characteristics and soil moisture. Thus, topography may influence soil productivity. Soil depth may also impact crop and livestock production. Shallow soils have lower moisture retention than deeper soils. As a result, deeper soils may influence production during dry years.

Different soil types don't necessarily have different levels of production. Farming techniques may vary from one soil to another resulting in similar yields even though the soils are different in many aspects. Similar soils in an area generally show similar responses in production due to a change in farming methods.

General Productivity Determination Information

Determining the productivity of agricultural land is the process of using the soil survey information and assigning a production value or yield/acre that represents the long-term average agricultural production capacity for a given acre of land. When applicable for an area, an adjustment to the soil survey productivity estimate is determined and applied throughout the area. Adjustments may also be made when producers within a general area provide sufficient evidence that the productivity estimate as determined in the soil survey does not accurately reflect production levels for the area.

Soil productivity is the output of a specified plant or group of plants under a defined set of management practices. ~~It is the single most important evaluation for farming.~~ In general, if irrigation is an optional practice, yields are given with and without irrigation. Productivity can be expressed in quantity of a product per unit land area, such as bushels or tons per acre. For pasture, productivity can be expressed as the carrying capacity of standard animal units (AUM) per unit area per season or year. The soil survey productivity may also be expressed as a rating or index related to either optimum or minimum yields, or it may be indexed to a set of soil qualities (properties) that relate to potential productivity. Productivity indices have the advantage of being less vulnerable to changes in technology than are expressions of productivity based on yields. The determination of productivity is based upon the production information contained in the NRCS soil survey.

When calculating productivity, the department considers typical management practices. Good managers are not penalized with above average productivity levels and poor managers are not rewarded with below average productivity levels. For instance, when most farms in an area are using accepted management practices and achieving similar

yield responses on a particular soil type, the productivity determination fits the production received by the majority.

Any acreage of reasonable size is delineated if a measurable variance in productive capacity is determined. Generally, five acres is the minimum resolution for productivity differences within a use class.

Land under farm buildings, irrigation ditches, road easements, water bodies, and brush-lined creeks are valued based on the productivity rating set for adjacent or surrounding land. Land under farm buildings and other man-made developments should be classified as grazing land but, is not assigned an arbitrarily low grazing productivity.

Non-Irrigated Farmland

Non-irrigated farmland includes non-irrigated summer fallow farmland and non-irrigated continuously cropped farmland. These lands produce farm crops without applying additional water to the land. Non-irrigated farmland productivity is determined based on the amount of spring wheat that can be produced per acre.

Spring wheat is set as the base crop in statute. Historically it was the most common small grain crop grown in Montana in both number of acres planted, and number of bushels produced. It also can be grown in all locations of the state whereas other small grains have limitations. Although spring wheat can be grown in all locations, it is not always the crop of choice.

The department uses the NRCS soil survey as the basis for this productivity. The spring wheat productivity information from the soil survey is adjusted to determine the productive capacity under typical management. The state is divided into three regional growing areas, each with an adjustment factor. This adjustment factor is determined by comparing the soil survey rating and the twelve-year weighted average of spring wheat production as published for the counties in the region as reported to ~~Montana~~ USDA National Agricultural Statistical Services (NASS) Montana. The department adjusts the NRCS productivity ratings by the appropriate regional factor to calculate an average production under typical management. The following map shows the current regional non-irrigated farm land adjustments.

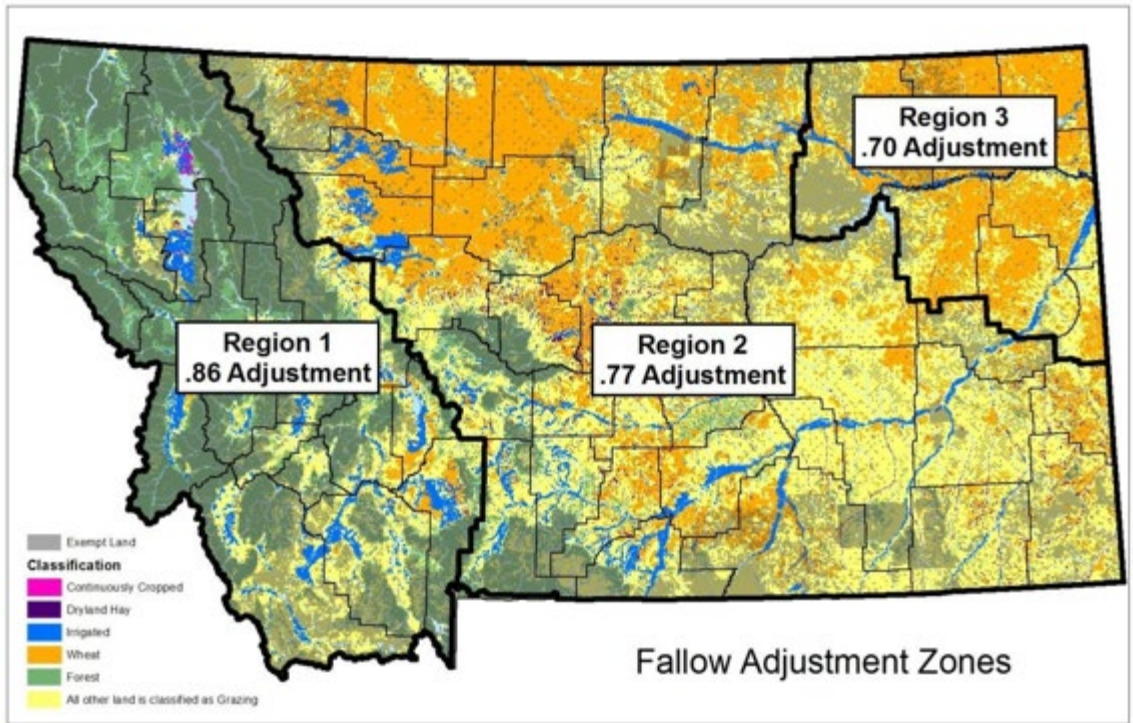

Non-Irrigated Continuously Cropped Hay Land

Non-irrigated continuously cropped hay land is also called "dry land hay" or "wild hay" land. This land classification is described in more detail in the Classification section of this manual.

Productivity of non-irrigated continuously cropped hay land is based on the total production of vegetation as published in the NRCS soil survey. The soil survey publishes data for total dry-weight production for each soil under favorable, normal, and unfavorable years. The department uses the midpoint of total dry-weight production for normal and unfavorable years to determine the productivity of non-irrigated hay land. This productivity is divided by 2,000 to arrive at tons/acre.

When there is a naturally high, water table present, sub-irrigation occurs. Sub-irrigation often results in higher productivity. Sub-irrigated hay fields are classified as non-irrigated hay land, rather than irrigated land. Typically, non-irrigated hay land produces only one cutting annually and sub-irrigated hay land often produces two cuttings per year.

Fertilization is not considered typical management for non-irrigated hay land.

Aftermath grazing refers to the use of a hay field for livestock grazing after the final hay harvest of the year. The soil survey includes aftermath grazing in its productivity estimate.

When discussing yield issues with a producer, any aftermath grazing should be included with the producer's estimate of productivity. Typically, aftermath grazing adds 25% to 33% to the land's total productivity. This estimate is made by adjusting the operator's hay production records to include the aftermath grazing.

The following two examples demonstrate how operator production data may be identical, but different management practices produce different production estimates.

Example 1 (Includes aftermath grazing from July 20-January 1)

- 10-acre hay field
- One cutting of non-irrigated hay per year
- 285 hay bales produced, 80-pound hay bales

Total Production: $285 \text{ bales} \times 80 \text{ pounds per bale} = 22,800 \text{ pounds of hay}$

Production per Acre: $\frac{22,800 \text{ pounds per ton}}{10 \text{ acres}} = 2,280 \text{ pounds per acre}$

Tons per Acre: $\frac{2,280 \text{ pounds per acre}}{2000 \text{ pounds per ton}} = 1.14 \text{ tons per acre}$

Aftermath grazing: $1.14 \text{ tons per acre} \times 1.333 = 1.52 \text{ tons per acre}$

Producer's estimate of Productivity: 1.52 tons per acre

Example 2 (No livestock aftermath grazing)

- 10-acre hay field
- One cutting application per year
- 285 hay bales produced, 80-pound hay bales

Total Production: $285 \text{ bales} \times 80 \text{ pounds per bale} = 22,800 \text{ pounds of hay}$

Production per Acre: $\frac{22,800 \text{ pounds per ton}}{10 \text{ acres}} = 2,280 \text{ pounds per acre}$

Tons per Acre: $\frac{2,280 \text{ pounds per acre}}{2000 \text{ pounds per ton}} = 1.14 \text{ tons per acre}$

Producer's estimate of Productivity: 1.14 tons per acre

Example 1, including aftermath grazing, produced a productivity rating higher than that of Example 2 with no aftermath grazing.

Irrigated Farm Land

Irrigated farm land is tillable crop land that receives water applications the majority of the years. It does not include irrigated grazing land. This land classification is further described in the classification section of this manual.

The productivity of tillable irrigated farm land is based on ~~the amount of~~ capability of the soil to produce alfalfa hay ~~the land is capable of producing~~ as provided by the NRCS soil survey. Alfalfa hay is set as the base crop because it is the predominant irrigated crop grown in Montana. Operators often include alfalfa hay production in their cropping sequence and are knowledgeable about alfalfa hay productivity.

Irrigation generally increases the productivity rating of the land. The type of soil becomes less important to production as the amount, quality, and consistency of irrigation increases. For example, irrigated hay land typically produces two to three cuttings annually, while non-irrigated hay land generally receives only one cutting per year.

Fertilization can increase productivity and is considered a typical practice for irrigated land.

The department does not change the productivity rating of irrigated land due to a different irrigation system. The productivity estimate will be the same regardless of the type of irrigation system being used.

Aftermath grazing may occur on irrigated farm land. Aftermath grazing is discussed in detail in the preceding Non-Irrigated Continuously Cropped Hay Land section.

Among other ~~things~~ factors, the NRCS productivity estimate is based on alfalfa at its highest point of production. The department bases valuation on the typical production so this rating may need to be adjusted. The adjustments are based on producer input related to the amount of water regularly applied to the land and average productivity. Adjustments, based on the percent of difference detected between the soil survey productivity rating and the reported productivity, are applied to the NRCS soil survey productivity for irrigated land within each county.

Grazing Land

Grazing land is land used primarily for livestock forage. The majority of Montana's agricultural land is grazing land, mostly native rangeland. The productivity of grazing land is based on the carrying capacity or number of animal unit months the land is capable of sustaining as published by the NRCS soil survey. The rating from the NRCS is based on what the soil would have produced in its natural state when all factors associated with productivity were in natural equilibrium.

Carrying capacity represents the number of animal units the land can support for a specific time period without causing injury to the land. In other words, it is the amount of grazing that a pasture can sustain due to the qualities of the soil and the environment where it occurs. [ARM 42.20.601](#).

Stocking rate represents the number of animal units an operator actually places on the land. Stated in other terms it is the number of specific animals grazing or utilizing a piece of land for a specific length of time.

Carrying capacity is not always equal to the actual stocking rate. It may be increased by management practices such as pasture rotation and developing water systems. Fertilization, weed spraying, and mechanical treatments are not considered typical management practices for grazing land. While management decisions may improve rangeland carrying capacity, the department does not penalize the producer with higher productivity ratings.

Grazing land productivity is based upon the soil's ability to produce palatable plants for livestock forage. Livestock graze on both poor and good rangeland. They prefer the bottomlands and areas near water, while grazing less on areas with steep hillsides, less desirable forage, and areas located at distance from their water source. Livestock grazing preferences depend on plant palatability, nutrition value, stage of plant growth, stocking rate, season of use, relative abundance, availability, and site location.

Overgrazing occurs when the stocking rate is greater than the carrying capacity. Undergrazing occurs when the stocking rate is less than the carrying capacity of the land. The

department does not reduce the land productivity rating due to poor management practices such as overgrazing.

Carrying Capacity Expressions

Productivity and carrying capacity are discussed in acres per animal unit month (Ac/AUM) or total animal unit months (AUM). These terms describe relationships between the number of animals and the acres grazed.

<u>Term</u>	<u>Abbreviation</u>	<u>Description</u>
Animal Units	AU	number of animal units
Animal Unit Months	AUM	amount of forage needed to sustain an animal unit for one month
AUM per Acre	AUM/Ac	number of animal unit months that one acre can support
Acres per AUM	Ac/AUM	number of acres required to support one animal unit for one month
Total AUM	AUM	number of animal unit months that the land area can support

Animal Units (AU)

An animal unit, the base measurement for productivity, is one cow-calf pair. A cow-calf pair consists of a 1,200-pound cow with a calf up to six months old. [ARM 42.20.601](#).

Animal units are added together to determine the total animal units. For example, a rancher has 50 cows each with a calf for a total of 50 animal units.

Animal Unit Months (AUM)

An AUM is the amount of vegetation required to feed one animal unit for one month. It is also a product of animal units and grazing time. This relationship is stated in the following equation and possible combinations that result.

$$\text{AUM} = \text{animal units} \times \text{months of grazing}$$

For example, a pasture that supports 12 AUMs could be used in any of the following combinations:

- | | | |
|------------------------|----|------------------------|
| 12 animals for 1 month | or | 1 animal for 12 months |
| 6 animals for 2 months | or | 2 animals for 6 months |
| 4 animals for 3 months | or | 3 animals for 4 months |

Grazing seasons are based on the typical period that livestock could graze without causing injurious effect to the overall health of the vegetation. The grazing season may extend from before the spring green-up of pastures to beyond the fall frost. The length of the grazing season and the amount of time that animals could graze the land impact the

number of animal units that a parcel of land can support. The department makes no determination on the length of time that livestock can graze on the land.

Generally, the department's total carrying capacity rating and the producer's stocking rate have a close correlation. The department does not determine which combination of time and animal units is best as this is the producer's management decision.

Animal Unit Months/Acre (AUM/Ac)

The department uses the term AUM/Ac when determining the productivity of grazing land. AUM/Ac expresses carrying capacity in the number of months that an animal unit can graze on one acre of land. AUM/Ac are determined by dividing the animal unit months by the number of grazing acres that are grazed.

Acres/Animal Unit Month (Ac/AUM)

Productivity and carrying capacity are often discussed in acres per animal unit month (Ac/AUM). This term is another expression of the relationship between the number of animals and the acres grazed for one month. Acres/AUM represents the acres that are required to support one AU for one month.

Calculating Carrying Capacity

The department uses the NRCS soil survey estimate for the pounds of total dry-weight production to determine the carrying capacity for grazing land. The soil survey publishes total dry-weight production estimates for a favorable year, normal year, and unfavorable year. The department uses the total dry-weight production estimate from the unfavorable year. This helps account for non-palatable herbage which may be included in the soil survey estimate. It also accounts for the fact that most privately owned rangelands in Montana do not exist in climax ecological conditions. Montana State University College of Agriculture recommended the use of this method.

The department uses .043 AUM/Ac as the lowest productivity placed on grazing land as recommended by the 2006 Governor's Agricultural Advisory Committee.

The total dry-weight production estimate from the soil survey is adjusted to reflect the amount of forage that is consumed by livestock. The department uses a 25% grazing efficiency factor. Ranchers typically allow ~~livestock to eat ½~~ half of the available forage to remain for sustaining the vegetative health of the land. This is referred to as the "take half-leave half" grazing philosophy and is a widely accepted method of managing grazing lands. It is intended to leave enough of the plant to allow for vigorous regrowth. ~~It is then assumed that ½ of the remaining herbage is not available for livestock use due to trampling, insect use or damage, and wildlife use, leaving ¼ of the total herbage available for use by livestock. For purposes of the following examples this will be referred to as the grazing efficiency factor.~~ The department assumes that half of the remaining herbage is not available for livestock use due to trampling, insects, wildlife, or other damage, leaving one-quarter of the total herbage available for livestock consumption. Therefore, the department uses a 25% "grazing efficiency factor" to estimate productivity.

Example:

Total dry-weight production under unfavorable conditions = 1,500 pounds

Take ½, leave ½ management = 750 pounds

½ wasted = 375 pounds (amount of forage available to livestock)

The department converts this estimate of forage produced into AUM/Ac using the following steps. First the feed requirements of an animal unit are calculated based on a **daily** feed requirement of 3% of the animal's weight. This equals 36 pounds of forage.

$$AU \text{ Daily feed} = 1200 \text{ pounds} \times 3\% = 36 \text{ pounds}$$

Then the daily feed requirement is multiplied by 30.5 days (average days per month in a leap year, $366 \div 12 = 30.5$) to convert the daily feed requirement to a **monthly** feed requirement.

$$1 \text{ AUM} = 36 \text{ pounds per day} \times 30.5 \text{ days per month} = 1,098 \text{ pounds.}$$

The third step involves multiplying the amount of total dry-weight production from the soil survey by the grazing efficiency factor to determine the forage available for livestock consumption.

$$\text{Total dry weight production (unfavorable year)} \times 0.25 = \text{actual livestock forage}$$

The fourth step results in the animal unit months/acre with the following calculation.

$$\frac{\text{Actual Livestock Forage}}{1098 \text{ Pounds}} = \text{animal unit months (AUMs)}$$

Since the NRCS soil survey data is in pounds per acre, the above calculation results in animal unit months per acre.

Here is an example of calculating the carrying capacity.

Given:

- Annual total dry-weight production (unfavorable) = ~~900~~ 880 pounds per acre.
- One AUM = 1,098 pounds.
- 25% grazing efficiency factor

Find: AUM/Acre

1. vegetation/acre x grazing efficiency factor = livestock consumption

$$\del{900} \text{ 880} \times 0.25 = \del{225} \text{ 220} \text{ pounds per acre}$$

2. ~~225~~ 220 pounds consumed per acre \div 1098 pounds/AUM = 0.20 AUM/Ac

3. Stated another way, it would take 5 acres of land to support one animal unit for one month. This expression, acres per animal unit months is the reciprocal of the previous step, calculated by dividing 1 by the AUM/Ac.

$$1 \div 0.20 \text{ AUM per acre} = 5 \text{ acres per AUM}$$

As shown the terms AUM/Ac and Ac/AUM are reciprocals of one another. In a reciprocal relationship, when one of the expressions is known, the other can be determined by dividing the known expression into one. Examples of reciprocals are as follows:

1. AUM per Acre converted to Acres per AUM

$$1 \div .25 \text{ AUM per acre} = 4 \text{ acres per Ac/AUM}$$

2. AUM per Acre converted to Acres per AUM

$$1 \div 4 \text{ acre per AUM} = .25 \text{ AUM per acre}$$

This shows the relationship between these expressions. An animal unit grazes one acre of land for 1/4 of a month. This in turn means that 4 acres are required to provide one month's forage for the animal unit.

When the expression AUM is divided by the number of acres in the pasture, the expression AUM/Ac is the result. For example, 20 AU X 5 months = 100 AUM, then, if the pasture used to graze the livestock is 300 acres, to calculate the expression Ac/AUM, simply divide the acreage by the AUM (300 Acres ÷ 100 AUM = 3 Ac/AUM).

The following examples demonstrate the calculation of stocking rate for AUM/acre and acres/AUM.

Example 1

An operator grazes 25 animal units for 2 months on 200 acres.

1. Animal unit months (AUM)

$$25 \text{ AU} \times 2 = 50 \text{ AUM}$$

2. Animal unit months per acre (AUM/Ac)

$$50 \text{ AUM} \div 200 \text{ Acres} = .25 \text{ AUM per acre}$$

3. Acres per animal unit month (Ac/AUMs)

$$200 \text{ Acres} \div 50 \text{ AUM} = 4 \text{ acres per AUM}$$

Example 2

An operator runs 26 cows with calves (cow-calf pairs) on a 180-acre pasture. The livestock spend a total of four months of the grazing season in the pasture to avoid overgrazing the native vegetation.

1. ~~There are 26 animal units.~~ Animal units (AU) (cow-calf pairs) = 26 AU

$$26 \text{ cow-calf pairs} = 26 \text{ AU}$$

2. ~~There are 104 animal unit months.~~ Animal unit months (26 AU x 4 months)

$$26 \text{ animal units} \times 4 \text{ months} = 104 \text{ AUM}$$

3. ~~There are .58 .578 animal~~ Animal unit months per acre (AUM/Ac)

- ~~104 animal unit months~~

- ~~180 grazing acres = .58 .578 AUM/Ac~~

- 4. Acres per animal unit month (Ac/AUM)
- 104 AUM ÷ 180 acres = .578 AUM/Ac

There are ~~1.73~~ acres per animal unit month

- ~~180 grazing acres~~
- ~~104 animal unit months = 1.73 Ac/AUM~~

One animal unit can be supported for one month on 1.73 acres. In this example, the total stocking rate is 104 AUM and the stocking rate per acre is 3578 AUM/Ac.

Example 3

A pasture has a carrying capacity of 3.0 Ac/AUM. We calculate the acres required to support 31 AUM as follows:

$$\frac{X}{3.0 \text{ acres per AUM}} = 31 \text{ AUM}$$

$$X = 31 \text{ AUM} \times 3.0 \text{ acres per AUM}$$

$$X = 93 \text{ Acres}$$

This pasture requires ~~93~~ 75 acres to support ~~31~~ 25 animal unit months of total carrying capacity.

Example 4

A 30-acre pasture has a carrying capacity of 2.5 Ac/AUM. We calculate the total carrying capacity as follows:

$$\frac{30 \text{ Acres}}{2.5 \text{ acres per AUM}} = 12 \text{ AUM}$$

These 30 acres have an annual carrying capacity of 12 AUM.

Agricultural Eligibility

Although land may be used in an agricultural manner, it must also meet specific eligibility requirements to receive agricultural land classification for property tax purposes. The criteria used depends on the size of the parcel of land. [15-7-202, MCA](#).

Parcel size is important as this determines the various income sources the owner may use to meet the qualifications of agricultural land classification. In general, the parcel size categories are described as:

1. Parcels of land consisting of 160 acres or more under one ownership automatically receive agricultural land classification unless the land is used for other purposes. Owners of these parcels are not required to fill out an Agricultural Land Classification Application (application). These parcels are taxed at the agricultural rate.
2. Parcels of land containing 20 acres or more but less than 160 acres under one ownership are eligible for classification as agricultural land if an

application has been submitted and approved. These parcels are taxed at the agricultural rate.

3. Parcels of land containing 20 acres or more but less than 160 acres that do not meet the agricultural eligibility criteria are classified as non-qualified agricultural land. Non-qualified agricultural land is valued at the statewide average productivity of grazing land. These parcels are taxed at seven times the agricultural rate.
4. Parcels of land less than 20 acres in size, under one ownership, are eligible for classification as agricultural land if an application has been submitted and approved. These parcels are taxed at the agricultural rate.
5. If a parcel of land less than 20 acres in size fails to meet the agricultural income and production requirements, it is classified as Class 4 tract land and receives a market value.

Eligibility Requirements

Agricultural classification is based on the land's ability to produce at least \$1,500 in annual gross income from agricultural products. Land that used to raise crops for consumption by livestock, poultry, or other agricultural animals rather than for direct marketing, must produce an equivalent of \$1,500 in annual gross income from agricultural products consumed and the livestock must be part of the agricultural operation.

Parcels of land containing less than 160 acres must qualify for agricultural classification through an application process. The land must be used primarily for raising and marketing agricultural products.

Six critical factors that affect agricultural land eligibility are:

1. The definition of agricultural
2. The definition of under one ownership
3. The amount of land owned
4. The agricultural income
5. The carrying capacity of grazing land for livestock operations
6. The relationship of the parcel to a family-operated agricultural entity

An applicant for agricultural land classification must prove the land indicated in the application is being used in an agricultural manner and produces \$1,500 in gross income annually. The income must be from an agricultural commodity produced from the land and marketed by the owner, owner's immediate family, agent, employee, or lessee to be considered for agricultural classification.

If the land is used merely as a platform or location for the agricultural production, then the land does not produce the agricultural product and is not eligible for agricultural land classification. Representative examples include crops that are produced in potted soil, and livestock which are fed from external sources to increase the stocking rate of the land.

Ownership size plays a role in the income sources allowed when applying for agricultural classification. Parcels of land consisting of at least 20 acres to less than 160-acres may use annual rental or lease payments if:

1. there is proof of agricultural use of the land and the land is capable of sustaining that activity.
2. annual rental payments of at least \$1,500 are received from the federal Conservation Reserve Program (CRP) or a similar program that reimburses the landowner to remove the land from the current agricultural use and place it in a different agricultural use.

Income Sources

Ownerships ~~less than~~ Less Than 20 acres Acres in size Size

Documentation of \$1,500 in annual gross income produced by the land must be submitted with the application. Allowable documentation for ownerships less than 20 acres in size include:

1. Sales receipts
2. Cancelled checks
3. Copy of income tax statements; ~~or~~
4. Other written evidence of sales transactions

Agricultural production or income produced by someone other than the land owner can be used to meet the agricultural income requirement.

For contiguous parcels less than 20 acres in size, the owner's source of income may not be from rental, lease, or government payments from programs such as the Conservation Reserve Program (CRP) or a similar program that reimburses the landowner to remove the land from the current agricultural use and place it in another use.

Although lease payments are not allowable sources of income, the agricultural production on parcels less than 20 acres in size produced by a lessee can be used by the landowner to meet the agricultural income requirement. Generally, the market value of the agricultural crops produced on leased land is higher than the actual lease payment involved in the lease agreement.

Ownerships 20 Acres to Less Than 160 Acres in Size

The owner must apply for agricultural classification and provide documentation of income produced by the land. Allowable documentation for contiguous ownerships 20 acres to less than 160 acres in size includes:

1. Sales receipts
2. Cancelled checks
3. Copy of income tax statements; ~~or~~
4. Other written evidence of sales transactions
5. Annual rental or lease payments; ~~or~~
6. Government payments under the Conservation Reserve Program or any similar program that reimburses the landowner to leave their land in a particular agricultural use.

An applicant for agricultural land classification may use the agricultural production or income that is produced from the applicant's ownership by a family member. The agricultural eligibility is based on agricultural production or income produced from land under one ownership. Family members cannot share agricultural production or income from different family ownerships.

Contiguous Ownerships 160 Acres or Greater in Size

Contiguous parcels under one ownership that consist of 160 acres or more are classified as agricultural unless the land is devoted to a residential, commercial, or industrial use. Owners of these agricultural parcels are not required to prove the agricultural income for purposes of classification.

Noncontiguous Parcels in the Same Ownership

Noncontiguous parcels under one ownership may combine income from these parcels to meet the \$1,500 income requirement.

1. Total size of the noncontiguous parcels is irrelevant.
2. All noncontiguous parcels must be part of the same unique ownership.
3. All noncontiguous parcels must be actively devoted to agriculture and an integral part of a bona fide agricultural operation.

Webster's Ninth New Collegiate Dictionary defines "integral" as "essential to completeness or formed as a unit with another part." A bona fide agricultural operation refers to a functioning agricultural business where the land in fact produces agricultural crops resulting in income to the associated agricultural business. [ARM 42.20.601](#).

Exceptions to the \$1,500 Income Requirement

If an application does not include proof of at least \$1,500 in annual gross income, the agricultural application should be denied except in very specific cases, as outlined below.

Consumption of products Products

When the agricultural products are consumed by livestock, rather than marketed, the applicant must prove that the land produced the equivalent of at least \$1,500 in annual gross income. If the agricultural products were consumed by livestock, poultry, or other animals in the agricultural operation, a written record of the weight or quantity of feed or plant fiber produced is an acceptable source of proof that the land truly produced the equivalent of \$1,500 in gross income each year from the agricultural products that were consumed. The weight or quantity estimate is multiplied by the current commodity price to determine the property's agricultural income. [ARM 42.20.620](#).

Grazing land requirement Land Requirement

Grazing land is required to meet or exceed a minimum carrying capacity as determined by the ~~Department of Agricultural Economics and Economics of Montana State University~~ Bozeman College of Agriculture. The university determines the animal unit months that equate to \$1,500 annual gross income. This sets the minimum carrying capacity required for grazing land to be classified as agricultural land. [15-7-202, MCA](#) and [ARM 42.20.681](#).

Production Failure or Marketing Delay

If the property has experienced a production failure due to drought or other condition beyond the producer's control for the source year of the application, production documentation from the previous year will be accepted.

If the producer has chosen to delay the marketing of their crop until a future date, production documentation from the previous year will be accepted.

Family Relationships

The association that an individual property owner has with a family farming or ranching business can be considered when determining agricultural eligibility for parcels of land between 20 and less than 160 acres in size that don't meet the \$1,500 annual gross income requirement on their own.

The requirements to qualify using the family farm relationship are as follows:

1. The parcel must be at least 20 acres in size
2. The parcel is located within 15 air miles of the family operated farm or ranch
3. The owner of the parcel must also meet the requirements of Option I or Option II:

Option I: At least 51% of the owner's annual Montana gross income is from agricultural production, and the property taxes are paid by a family corporation, family partnership, sole proprietorship, or family trust involved in Montana agriculture, and 51% of the entity's Montana annual gross income is from agricultural production;

Option II: The owner is a shareholder, partner, owner, or member of the family corporation, family partnership, sole proprietorship, or family trust that is involved in Montana agricultural production, and 51% of the person's or entity's Montana annual gross income is from agricultural production.

Provisional classification with ownership transfer

When an agricultural property changes ownership, the property is classified and assessed as agricultural land by the department for the remainder of the current year.

If the new owner files a timely agricultural land classification application and states that the property will continue in the same agricultural use, the department will grant provisional agricultural classification for one year to allow the new owner time to grow and market agricultural products produced by the property.

Example - A taxpayer purchases a property on December 31 of the previous year. The property was classified as agricultural land under the previous owner. The new owner files a timely agricultural land classification application with the local department office. The new owner states that the property will continue to be managed as an agricultural operation in the same use for the current year.

The property met the agricultural eligibility requirements on January 1 of the previous year for the previous owner. The department classifies and assesses the property as

agricultural land for the current year. The department may ask the new owner to file another agricultural land classification application the following year to demonstrate that the property continues to meet the agricultural land eligibility requirements pursuant to [ARM 42.20.620](#).

Once land qualifies for agricultural classification, it remains so classified until it no longer meets criteria, changes ownership, or is subdivided.

Classification

~~Agricultural lands are placed in a separate property tax class, Class 3, which includes:~~

- ~~• Agricultural land~~
- ~~• Nonqualified agricultural land~~
- ~~• Nonproductive patented mining claims~~

~~Section [15-6-133, MCA](#).~~

~~Land is classified based on its agricultural use, and sub-classified according to the soil's ability to produce crops or livestock. [15-7-103, MCA](#) and [15-7-201, MCA](#). Typically, current use is the guiding principle to determining classification, though it may be based on historic use in some situations. Agricultural lands are Class 3. [15-6-133, MCA](#). Class 3 property includes agricultural land, nonqualified agricultural land, and nonproductive patented mining claims. The department may follow its land use maps, agricultural land use criteria, information obtained from on-site field reviews, operator and landowner interviews, inspections by department staff, and GIS information to identify land use. [ARM 42.20.602](#).~~

~~Land is classified based on its agricultural use and sub-classified according to the soil's ability to produce crops or livestock. [15-7-103, MCA](#) and [15-7-201, MCA](#).~~

~~The department is required to value agricultural land at its productive capacity, not its highest and best use. [15-7-103, MCA](#).~~

~~Because the market value of many agricultural properties is based upon speculative purchases that do not reflect the productive capability of agricultural land, it is the legislative intent that bona fide agricultural properties be classified and assessed at a value that is exclusive of values attributed to urban influences or speculative purposes. Classification may be based on historic or current use, depending on the situation. Typically, current use is the guiding principle to determining classification. If an operator converts an agricultural use to a different use, the change is reflected on the following year's assessment.~~

However, agricultural classification is sometimes based on the operator's long-term management objectives. When crops are grown in a cropping sequence, the long-term management practices dictate the land classification. For example, land may historically be used as summer fallow farm land. As such, the operator may rotate small grain production with alfalfa to restore soil nutrients, soil structure and reduce the chance of certain diseases.

Unless the operator's intention is to change his long-term management objectives, the land classification continues to be summer fallow farm land. It is not unusual for operators to practice multiple agricultural uses on the same acreage. The same land may be irrigated, hayed, and grazed in the same season. Specific rules apply depending on the use.

Agricultural land is classified based on the land's agricultural use as set forth in [15-7-201](#) (1) through (3), MCA, and [15-7-103](#) (2) through (4 5), MCA.

[ARM 42.20.601](#) defines a bona fide agricultural operation as an agricultural enterprise in which the land actually produces agricultural crops defined in [15-1-101, MCA](#), that directly contribute agricultural income to a functional agricultural business. By this definition, properties involved in an actual agricultural enterprise are considered a bona fide agricultural operation. Criteria for agricultural eligibility are set to determine if a bona fide agricultural operation can be classified as agricultural land as provided in [15-7-202, MCA](#).

The department must classify agricultural land according to its use, including irrigated, non-irrigated, and grazing land, [15-7-201\(2\), MCA](#). The department currently uses the following agricultural land use categories.

1. Non-irrigated summer fallow farm land ([ARM 42.20.676](#))
2. Non-irrigated continuously cropped farm land ([ARM 42.20.676](#))
3. Irrigated farm land ([ARM 42.20.675](#))
4. Non-irrigated continuously cropped hay land ([ARM 42.20.676](#))
5. Grazing land ([ARM 42.20.676](#))

Within each class, the land must be sub-classified according to its productive capacity. Productive capacity is determined based on yield, [15-7-201, MCA](#).

Non-irrigated Summer Fallow Farm Land

Crops grown on summer fallow land include, but are not limited to, small grains such as wheat, oats, barley, safflower, and sunflower. Summer fallow is the farming practice of leaving land idle with no vegetative growth. Typically, summer fallow farm land is cropped every other year. This management practice is generally done to promote the accumulation of soil moisture and promote weed and disease control.

The practice of double or triple cropping land is called re-crop. Re-crop is the practice of producing a crop for two or three successive years on land that is typically cropped every other year. Re-cropping may be done for a variety of reasons, including economic reasons or to control excess moisture conditions that may be leading to high saline levels in the soil. The summer fallow farm land classification includes the practice of double or triple cropping the land.

Another common practice in certain areas of the state is to grow grain crops one year, and a legume crop, or pulse crop, such as peas or lentils the following year. This type of crop rotation may result in a crop being grown every year, but for department purposes this practice is still considered re-cropping, and the land continues to be classified as summer fallow farm land.

Operators may also rotate hay crops into a cropping sequence. For example, land that is used as summer fallow may be planted to alfalfa hay for several years to restore certain nutrients to the soil. Land that is typically in summer fallow management should remain in summer fallow farm land classification, even when the land is rotated into a hay crop such as alfalfa for a short length of time.

Non-irrigated Continuously Cropped Farm Land

Continuously cropped farm land requires a combination of climate, soils and rainfall found exclusively in these northwestern Montana counties: Flathead, Lake, Lincoln, Mineral, Missoula, Ravalli, and Sanders. This land is cropped at least 75 percent of the time historically. Continuous cropping must be the accepted long-term practice in the area. Re-cropped farm land, discussed earlier in the manual, should not be confused with continuously cropped farm land.

Non-irrigated Continuously Cropped Hay Land

Non-irrigated continuously cropped hay land is land that is hayed more than 50 percent of the years over the long term (11 years out of the past 20 years). Hay land includes native vegetation, domestic grasses, and non-irrigated alfalfa. Native or domestic grassland that is hayed occasionally when there is above average precipitation is classified as grazing land, not hay land.

Hay land that is intermittently irrigated is classified as hay land, not tillable irrigated farmland. This situation commonly occurs on land located in arid to semi-arid regions of the state in which the owner installs spreader irrigation dikes. Infrequent or light rainfall may mean the land only receives one water application every few years.

Hay fields located along creeks and rivers may experience natural sub-irrigation. Sub-irrigated hay land that receives water from natural sources is classified as hay land.

Land must receive water from man-made irrigation delivery systems to be classified as tillable irrigated land.

A cropping sequence that temporarily takes land out of hay production and places the land into a different crop remains in the hay land classification. Alfalfa has a productive life of 7 to 10 years. After that, the plant begins to die out and is replaced by other plant species. At the end of alfalfa's productive life, the operator often plants small grains for a few years before replanting a new alfalfa stand.

Irrigated Farmland

Farm land that is tillable and irrigated a majority of years is classified as irrigated farm land. A majority of years means more than 50 percent over the long term; for example, 11 years out of the past 20 years. Location within an irrigation district is not automatically classified as irrigated but classified according to its use. Irrigated grazing land is classified as grazing land if the land is used solely by foraging livestock. If an irrigated crop is harvested from the land followed by livestock aftermath grazing, the land is classified as irrigated land.

The land must have reasonable amounts of water available for periodic applications over the long-term and the water must be applied to the land. Short-term drought is not a basis

for removing land from the irrigated classification unless it is the intent of the operator to discontinue irrigation over the long-term. Land that receives intermittent water applications less than 50 percent of the years is not classified as irrigated land. For example, infrequent or light rainfall may mean land with spreader dikes only receives one water application every few years.

Grazing Land

Rangeland used for grazing livestock is classified as grazing land. Native or domestic grassland occasionally harvested for hay is classified as grazing land, not hay land. Irrigated pastures are also classified as grazing land.

Land under water bodies, road easements, irrigation ditches, barns and other farm structures is classified as grazing at the productive rating of the land under these structures. [15-7-206, MCA](#).

Agricultural Valuation

Agricultural values are based on the productive capacity of the land, i.e., the ability of the land to produce income from cash crops and livestock, including but not limited to, spring wheat, alfalfa, and private grazing fees.

Statute mandates the valuation process for Class 3 properties. It describes how the valuation will be computed, the valuation formula to be used, the types and sources of the data used in the formula, and the appointing of the Governor's Agricultural Land Advisory Committee. This committee reviews the valuation of agricultural properties and provides policy recommendations to the department. A new committee is chosen by the Governor every four years- [as provided in 15-7-201, MCA](#).

The statutory formula for determining productive capacity value is:

$$\text{Value of Each Type of Agricultural Land} = \frac{\text{Net Income of Each Type of Agricultural Land}}{\text{Capitalization Rate}}$$

Or $V = \frac{I}{R}$ where:

V = value of each type of agricultural land

I = net income of each type of agricultural land

R = capitalization rate

Example of Calculation

• ~~Net Income per Acre = \$50~~

• ~~Capitalization Rate = 6.4%~~

$$\text{Value per Acre} = \frac{\$50}{6.4\%} = \$781.25$$

See [15-7-201, MCA](#). The department provides examples of each land valuation calculation in ~~Addendum A~~ [Appendix B](#).

Commodity Price information

Commodity price data and cost of production data for the base period must be obtained from the Montana Agricultural Statistics, the Montana crop and livestock reporting service, and other sources of publicly available information if considered appropriate by the advisory committee. [15-7-201, MCA](#).

An average of agricultural commodity prices over a legislatively specified base period is used to represent gross income for the multi-year appraisal cycles. The base period is a ten-year Olympic average that is designed to smooth price volatility. The ten-year Olympic average is calculated by using data from ten consecutive years, dropping the highest and lowest figures, then averaging the remaining eight years.

Base Crops

Although a variety of crops and livestock are produced in Montana, only three commodity prices are used to calculate gross income for assessment purposes. The source for these prices is the Montana Agricultural Statistics Reporting Service.

The base crop for valuation of non-irrigated hay land and irrigated land is alfalfa hay, adjusted to 80% of the sales price. The base crop for valuation of non-irrigated farm land is spring wheat. The base unit for valuation of grazing lands is animal unit months (AUM), defined as the average monthly requirement of pasture forage to support a 1,200-pound cow with a calf or its equivalent. [15-7-201, MCA](#).

These base crops are used in the valuation of agricultural lands in the following land use types.

Bushels of Spring Wheat	<ul style="list-style-type: none">Continuously cropped farmlandSummer fallow farmland
Tons of Alfalfa Hay	<ul style="list-style-type: none">Irrigated landContinuously cropped hay land
Private Lease Fee per Animal Unit Month (AUM)	<ul style="list-style-type: none">Grazing land

Crop Share

Expenses are estimated for assessment purposes, using a crop share percentage typical to the market. Agricultural properties can be leased with a crop share arrangement. In this type of lease, the landlord receives a set proportion of the crop produced as the rent. Since all expenses are typically paid by the tenant, the landlord's share represents the land's net income.

The crop share rental percentages used in the valuation of agricultural lands are as follows:

Agricultural Land Classification	Landlord's Crop Share
<i>Continuously cropped farmland</i>	$\frac{1}{4}$ (25 percent)

<i>Summer fallow farmland</i>	<i>1/8 (12.5 percent)</i>
<i>Continuously cropped hay land</i>	<i>1/4 (25 percent)</i>
<i>Irrigated land</i>	<i>1/4 (25 percent)</i>
<i>Grazing Land</i>	<i>25% management fee</i>

Gross and Net Income

Gross income is calculated by multiplying the per-unit price for the base crop by the quantity produced on an acre of land.

Example:

- Alfalfa hay commodity price = ~~\$105.80~~ 111.30/ton
- Land productivity = 1.2 tons/acre

Gross income calculation:

$$\del{105.80} \text{ } 111.30 \text{ per ton} \times 1.2 \text{ tons per acre} = \del{126.96} \text{ } 133.26 \text{ per acre}$$

Net income per-acre is calculated by deducting agricultural costs from the gross income. This calculation involves multiplying gross income by the landlord's crop share percentage.

Example:

- Gross income = ~~\$126.96~~ 133.56/acre
- Crop share = 25%

Net income calculation

$$\del{126.96} \text{ } 133.56 \text{ per acre} \times 0.25 = \del{31.74} \text{ } 33.39 \text{ per acre}$$

Capitalization Rate

The capitalization rate converts an income stream into present value. This process estimates a property value by converting the future financial benefits of ownership into an expression of present worth. Value equals net operating income divided by the capitalization rate. The use of capitalization rates is an accepted appraisal practice to estimate the value of income producing properties.

Statute sets the capitalization rate at 6.4 percent unless a different rate is recommended by the agricultural advisory committee and ~~the department adopts that rate by rule.~~ subsequently adopted by the department, as provided in [15-7-201, MCA](#).

Within each agricultural use classification, the productivity of the land is determined based upon the soil's ability to produce the crops or sustain livestock on the land. Agricultural land is valued based on the land's productive capacity, i.e., the ability of the land to produce income from cash crops such as spring wheat and alfalfa and livestock. The assessed values for agricultural lands are calculated by capitalizing the net agricultural income for each specific land use.

The addendum [Appendix B](#) provides examples of valuation calculations for each agricultural use. The productivity varies according to the individual property.

Irrigated Land Valuation

The values for irrigated land are calculated by capitalizing the net agricultural income for irrigated lands. The department calculates net income for irrigated land by multiplying gross income for irrigated land by the crop share and deducting the allowable water cost of \$50 per acre. [15-7-201, MCA](#). The valuation formula is shown as:

$$V = \frac{(I \times Share) - WC}{R}$$

Where:

- V = Value
- I = Gross Income
- Share = Crop share percentage
- WC = Water cost
- R = Capitalization rate

~~The water cost component was the sum of three components until the 2019 Legislature passed House Bill 24 (HB 24) to simplify the valuation process for all irrigated land. HB 24 amendments to [15-7-201, MCA](#), sets the allowable water costs for all irrigated land at \$50 per acre, effective with the 2021 appraisal. This eliminated the need for owners to submit their energy costs to the department. It also makes it unnecessary for the department to identify the type of irrigation system used on the irrigated land as this is no longer tied to the valuation of the land.~~

Minimum Value of Irrigated Land

Irrigated land must be valued at or above the value it would have if it wasn't irrigated. [15-7-201, MCA](#). The department determines the minimum value for irrigated land using the non-irrigated continuously cropped farm land method with a productivity of 23 bushels of spring wheat per acre. [ARM 42.20.675](#). The minimum value for the current appraisal cycle is stated in [ARM 42.20.681](#).

For example, the irrigated minimum value is determined as follows:

- Productivity = 23 bushels per acre
- Commodity Price = ~~\$6.16~~ 5.96/bushel
- Capitalization Rate = 6.40%

~~Gross Income = 23 bushels per acre × \$6.155 5.96 per bushel = \$141.565 137.08 per acre~~

~~Net Income = \$141.565 137.08 per acre × 0.25 = \$35.39 34.27 per acre~~

~~Minimum Land Value = $\frac{\$35.39 34.27}{.064} = \$552.99 535.47$ per acre~~

Specialty Crops

Most agricultural crops and forage are produced on an annual basis. However, certain crops are grown for multiple years. These crops are classified as specialty crops. Examples of specialty crops include fruit tree orchards, berry bushes and trees, Christmas trees and vineyards.

Specialty crops may also refer to unique crops, such as apiaries, biological control insects, gardens, produce farms, floriculture, nurseries, poultry, game bird farms, and sod farms. Biological control insects are insects used to reduce or control noxious weeds. Poultry are domesticated birds raised to produce eggs, meat, and other marketable products. [ARM 42.20.601](#).

All agricultural lands that are producing specialty or unique crops are assigned the highest productivity level of non-irrigated continuously cropped farm land. This is based on a decision by the Governor's Agricultural Advisory Committee.

These crops are classified as non-irrigated continuously cropped farm land even if the land is irrigated. Any residual land on the parcel that is not used to produce these crops is classified and valued based on its use and productive capacity.

Specifics regarding the classification and valuation of specialty crops can be found in [ARM 42.20.620](#), [42.20.681](#), and [42.20.683](#).

Nonqualified Agricultural Land

Nonqualified agricultural land is determined by size. Nonqualified agricultural land is defined as parcels 20 acres to less than 160 acres under one ownership, not used for residential, commercial, or industrial purposes and not eligible for valuation, assessment, and taxation as agricultural land. [ARM 42.20.601](#) and [42.20.650](#).

Nonqualified agricultural land is placed in property tax Class 3 with agricultural land and nonproductive patented mining claims. Nonqualified agricultural land is valued as grazing land at the statewide average productivity and a taxable percentage seven times the taxable percentage for agricultural land. [15-6-133, MCA](#). [ARM 42.20.650](#) and [42.20.681](#).

Nonproductive Patented Mining Claims

Nonproductive patented mining claims (NPPMC) are included in Class 3 property with agricultural and nonqualified agricultural properties, NPPMC are classified and valued at the statewide average productivity value of grazing land. [15-6-133, MCA](#) and [ARM 42.20.307](#). For NPPMC classification the parcel must meet the requirements of this section.

A patented mining claim is a property where the federal government transferred the title, including mineral patent, to a private party for the sole purpose of developing a mining operation. The mineral patent gives the owner title to the surface of the property, minerals, and other resources. [ARM 42.20.302](#) and [42.20.303](#).

"Nonproductive land" means non-fertile land that is incapable of supporting animals or producing plant matter in commercially salable quantities.

Although some minerals may have been removed in previous mining operations, the mineral deposits must not be depleted, however, the mine cannot currently be in operation. When mining resumes, the property is no longer eligible for this classification.

The property must be located outside the limits of an incorporated town. In the case of a county-municipal consolidation, the property must have been outside the limits of the municipality prior to the consolidation date.

Patented mining claims used for recreational, commercial, industrial, agricultural or forest land use are not eligible for treatment as a NPPMC. [15-6-133, MCA](#). The department provides the following examples of these uses:

1. filing a certificate of survey that creates a division of the mining claim;
2. growing agricultural commodities on the mining claim; ~~or~~
3. leasing any portion of the surface area for a recreational, commercial, residential, industrial, or agricultural use. [15-6-133, MCA](#), and [ARM 42.20.302](#).

Improvements that would be otherwise used in the mining operation are allowable. However, improvements that change the use of the land to recreational, residential, commercial, industrial, forest land, or agricultural use make the property ineligible for classification as a NPPMC. If any of the following improvements are located on a patented mining claim, it cannot be classified and valued as a NPPMC:

1. residential structures, including cabins, ~~houses, or mobile homes, manufactured homes, and trailers, regardless of foundation attachment or water or septic hook-ups;~~
or
2. ~~mobile homes and trailers regardless of foundation attachment, and/or water and/or septic improvements, or~~
- 3 2. any commercial or industrial structures used to produce income.

Improvements on NPPMC such as vacant outbuildings or garages that were used for storing mining machinery, equipment, or other mining materials when the claim was active are allowed on a NPPMC. The land under allowable improvements, including the land necessary for the use of these improvements, is classified, and valued as class 4 property. [ARM 42.20.305](#). The remainder of the patented mining claim is classified and valued as a NPPMC. [15-6-133, MCA](#), and [ARM 42.20.301](#).

Homesites

When a residence exists on an agricultural, nonqualified agricultural, or forest parcel, the department identifies one acre under the residence as a homesite for classification and valuation purposes as governed by [15-6-133](#) and [15-6-134, MCA](#), and [ARM 42.20.655](#).

~~A residence is any fixed dwelling that is constructed and used for human habitation. The structure must contain, at a minimum, sleeping facilities. It does not have to contain water and sewer/septic amenities. Occupancy of the residence is irrelevant.~~

A residence, also known as a dwelling, is a structure designed or occupied as the living quarters of one or more households; usually equipped with cooking, bathing, toilet, and

heating facilities, where necessary. (Appraisal Institute Dictionary of Appraisal Terms, 7th edition)

For purposes of identifying homesites, the term residence includes any structure that contains living area such as SFR, outbuildings with living area, and dry cabins. Occupancy of the residence is irrelevant.

Any building used entirely for storage is not considered a residence. Garages, outbuildings, and agricultural structures are not considered residential improvements.

A one-acre homesite may contain multiple residences provided the residences are located within the same one-acre area. When a property has multiple residences that are not located within a single one-acre area, a one-acre homesite must be designated for each residence.

If an agricultural parcel is less than one acre in size and contains a residence, the entire parcel is classified as an agricultural homesite. No additional area shall be classified as a homesite on adjoining parcels for this residence. A homesite does not cross parcel boundaries. When a farmstead crosses a parcel boundary with residences on both parcels, a separate one-acre homesite must be designated for each parcel.

A homesite is not assigned to a site that contains only a well and septic system without a residence. For example, a homesite is assigned to land that contains a well, septic system and a manufactured home. If the manufactured home is removed from the site, leaving the land without a residence, then the one-acre homesite is removed from the land's assessment. Land with a manufactured home that is not ~~permanently attached to a foundation or connected to water and/or septic improvements~~ used as a residence, is not assigned a one-acre homesite.

When a parcel contains both forest and agricultural land, the homesite location is important. If the homesite is located within the forest portion of the parcel, the correct classification is a forest homesite. If the homesite is located outside of the forest portion, the correct classification is an agricultural homesite.

Improvements such as barns, sheds, silos, cribs, and like structures are considered agricultural improvements not residential improvements. Land under agricultural improvements is classified as grazing land and valued according to the agricultural productivity of the land. [15-7-202](#) and [15-7-206, MCA](#). If these improvements are located on the one-acre homesite, no additional land classification is needed. Residential tract land does not receive a one-acre homesite designation.

When land under one ownership contains less than 20 acres total with at least 15 acres of forest land and has remaining acres of non-forest land, if the non-forest land does not meet the agricultural eligibility requirements, the non-forest land is valued at market. If the residence on these parcels is surrounded by nonagricultural land, the land under the residence is not assigned a one-acre homesite. The non-forest land is classified as class 4 land and assessed at its market value.

Land under commercial or industrial improvements, on either Class 3 or Class 10 property, is not assigned a one-acre homesite. The ~~actual amount of~~ land under the commercial or industrial improvements and the land that supports those improvements

must be classified as Class 4, commercial or industrial. An example of a commercial improvement on a parcel containing agricultural land is a riding arena that is used to produce nonagricultural income. An example of an industrial improvement on a parcel containing forest land is a wood products plant.

Examples:

1. An agricultural property has a residence ~~on the property~~, the parcel is assigned a one-acre homesite.
2. An agricultural property has a primary residence with an adjacent guesthouse all located on the same one acre, the parcel is assigned a one-acre homesite, even though the parcel contains two residences.
3. A farm has several residences that are not located on the same acre, a one-acre homesite must be assigned to land under each residence.
4. A landowner owns contiguous agricultural parcels ~~in the same~~ under one ownership. The parcel with the residence is less than one acre in size. The entire parcel with the residence must be classified as an agricultural homesite.
5. ~~An ownership has~~ A landowner owns two contiguous parcels under one ownership. There are two houses located within one acre, but they are on two different each of contiguous parcels. A one-acre homesite must be assigned on each parcel.
6. A summer home or cabin without a septic system ~~and/or well~~, is appraised as a ~~residential structure~~ residence and the land under the structure is classified as a homesite.

Reference the following tables for homesite classification:

When a homesite is located on the agricultural land, the following scenarios apply:

The department proposes to remove first table below and add the following three tables.

Classification of One Acre Homesites					
Situation	Ag Homesite	NQ Homesite	Forest Homesite	Tract land	Remainder acres
Ag parcel less than one acre in size with a residence	Entire parcel size				n/a
Ag parcel with a residence	1 acre FSA				Enter remaining acres in

					appropriate land use item pages
Ag parcel with multiple residences on one acre	1 acre FSA				Enter remaining acres in appropriate land use item pages
Ag parcel with multiple residences on separate sites	1 acre FSA for each site				Enter remaining acres in appropriate land use item pages
Ag parcel with multiple residences in one location but doesn't fit on 1 acre	1 FSA for each residence as needed to fit on one acre sites				Enter remaining acres in appropriate land use item pages
NQ parcel with a residence		3NQ-1Ac. homesite			Enter remaining acres in NQ land item page
Forest parcel with a residence			3FOR-1Ac. homesite		Enter remaining acres in appropriate land use item pages
Residential parcel with a residence				Follow residential guidelines	
<ul style="list-style-type: none"> • FSA means Farm Site on Agricultural land. • 3NQ-1 Ac. Means a 1-acre homesite on nonqualified agricultural land. • 3FOR-1 Ac. means a 1-acre homesite on forest land. 					

Classification of One Acre Homesites					
Situation	Ag Homesite	NQ Homesite	Forest Homesite	Tract land	Remainder acres
Ag parcel less than one acre in size with a residence*	Farmsite on agricultural land - entire parcel size				n/a
Ag parcel with a residence*	Farmsite on agricultural land - 1 acre				Enter remaining acres in appropriate land use item pages
Ag parcel with multiple residences* on one acre	Farmsite on agricultural land - 1 acre				Enter remaining acres in appropriate land use item pages
Ag parcel with multiple residences* on separate sites	Farmsite on agricultural land - 1 acre - for each site				Enter remaining acres in appropriate land use item pages
Ag parcel with multiple residences* in one location but don't fit on 1 acre	Farmsite on agricultural land - for each residence as needed to fit on one acre sites				Enter remaining acres in appropriate land use item pages
Residential parcel with a residence*			Follow residential guidelines		
*residence applies to any building with habitable area					

When a homesite is located on the nonqualified agricultural land, the following scenarios apply:

Classification of One Acre Homesites					
Situation	Ag Homesite	NQ Homesite	Forest Homesite	Tract land	Remainder acres
NQ parcel less than one acre in size with a residence*		1 Ac. Beneath Improvements (for dwlg on NQ Ag Land) - entire parcel size			n/a
NQ parcel with a residence*		1 Ac. Beneath Improvements (for dwlg on NQ Ag Land)			Enter remaining acres in NQ land item page
NQ parcel with multiple residences* on one acre		1 Ac. Beneath Improvements (for dwlg on NQ Ag Land)			Enter remaining acres in appropriate land use item pages
NQ parcel with multiple residences* on separate sites		1 Ac. Beneath Improvements (for dwlg on NQ Ag Land) - for each site			Enter remaining acres in appropriate land use item pages
NQ parcel with multiple residences* in one location but don't fit on 1 acre		1 Ac. Beneath Improvements (for dwlg on NQ Ag Land) - for each residence* as needed to fit on one acre sites			Enter remaining acres in appropriate land use item pages
Residential parcel with a residence*			Follow residential guidelines		

*residence applies to any building with habitable area

When a homesite is located on the forest land, the following scenarios apply:

Classification of One Acre Homesites					
Situation	Ag Homesite	NQ Homesite	Forest Homesite	Tract land	Remainder acres
Forest parcel less than one acre in size with a residence*			1 Ac. Beneath Improvements (for dwlg on Forest Land) - entire parcel size		n/a
Forest parcel with a residence*			1 Ac. Beneath Improvements (for dwlg on Forest Land)		Enter remaining acres in appropriate land use item pages
Forest parcel with multiple residences* on one acre			1 Ac. Beneath Improvements (for dwlg on Forest Land)		Enter remaining acres in appropriate land use item pages
Forest parcel with multiple residences* on separate sites			1 Ac. Beneath Improvements (for dwlg on Forest Land) - for each site		Enter remaining acres in appropriate land use item pages
Forest parcel with multiple residences* in one location but don't fit on 1 acre			1 Ac. Beneath Improvements (for dwlg on Forest Land) - for each residence* as needed to fit on one acre sites		Enter remaining acres in appropriate land use item pages
Residential parcel with a residence*			Follow residential guidelines		

*residence applies to any building with habitable area

Multiple land use classifications (i.e. agricultural land/forest land, nonqualified agricultural land/forest land, agricultural land/Class 4 land, forest land/Class 4 land) may exist on a single parcel of land, but a single parcel can never contain both agricultural and nonqualified agricultural land classifications.

When a parcel contains multiple land uses, the type of land use that surrounds the residence dictates the appropriate homesite classification. Aerial photographs, property record cards, property photographs, and physical inspections are used to identify the type of land use that surrounds the residence. The location of the homesite is identified and the one-acre homesite deducted from the appropriate land use classification.

It is extremely important to determine the correct land use for the homesite because valuation of the property is dependent on the classification of the homesite and remaining acreage. Homesites on agricultural land are valued at the highest productivity value of agricultural land in the state. [15-7-206, MCA](#) and [ARM 42.20.655](#). Homesites on nonqualified agricultural land are valued based on comparable land sales: as set forth in [15-6-134, MCA](#) and [ARM 42.20.655](#). Homesites on forest land are valued based on comparable land sales. [ARM 42.20.725](#).

Remove the following table and replace with the lower table.

Homesite Type	Homesite Code	Valuation Method
Residential Tract		Market Value
Agricultural Homesite	FSA	Highest Statewide Ag Value
Nonqualified Homesite	3NQ	Market Value
Forest Homesite	3FOR	Market Value

Homesite Type	Valuation Method
Agricultural Homesite	Highest Statewide Ag Value
Nonqualified Homesite	Market Value
Forest Homesite	Market Value

The remaining land, after the homesite is designated, is classified with the correct land use and productivity.

Cadastral Information

A cadastre is a comprehensive register of the metes and bounds of a country's real property. It commonly includes details of the ownership, such as the precise location (which may include GPS coordinates, dimensions and area), cultivation if rural, and the value of individual parcels of land. Cadastral maps show the boundaries and ownership of land parcels and may include other property information such as survey districts, unique identifying numbers for parcels, certificate of survey numbers, structure locations, section and/or lot numbers and their respective areas, street and road names, boundary dimensions and references to prior maps.

Montana Cadastral Map

The department provides ownership information and parcel boundary lines to the Montana Department of Administration/Information Technology Services Division/GIS services. In turn, GIS Service incorporates this information into their cadastral database which is used in the on-line Montana cadastral map.

Geographic Information System (GIS)

The 2005 Montana Legislature provided funding for the department's Property Assessment Division to develop a geographic information system (GIS). The department started using GIS for the 2009 reappraisal. The computer software links geographic information (location of item) with the item's descriptive information. A Geographic Information System (GIS) integrates hardware, software, and data for capturing, managing, analyzing, and displaying all forms of geographically referenced information in a map.

~~A GIS is a set of intelligent maps and other views that show features and feature relationships on the earth's surface.~~ Unlike a paper map, where only the location is displayed, GIS maps can present many layers of different information that show features and feature relationships on the earth's surface. State and local governments are increasingly required to streamline business practices while adhering to complex political or regulatory requirements. GIS provides a flexible set of tools to perform the diverse functions of government by providing the data management tools needed and makes it easier to share data among departments.

The department began the process of ~~creating the~~ implementing GIS in the summer of 2005. The 2006 – 2008 Agricultural Land Advisory Committee (Committee) reviewed the planned ~~usage of the~~ use of GIS, developed an understanding of the general concepts associated with using a GIS for agricultural land reappraisal. The committee ~~and~~ concurred that it GIS was the most efficient and accurate method for reappraisal purposes. The ~~Committee~~ committee provided recommendations to the department for the use of GIS technology in the reappraisal of agricultural lands.

The department uses GIS technology to update and maintain the agricultural and forest land systems. GIS provides updated maps to counties on an on-going basis. These maps are extremely useful for staff for reviewing and discovering land use changes, and for keeping current with updated boundaries and ownership changes.

Important Dates

Appraisal Date

The department reviews land use changes and eligibility annually. The department classifies property according to its use as of January 1 to determine the correct land classification for a given tax year. The eligibility of land for Class 3 tax assessment is based on the land's use, agricultural income, if applicable, and property size the preceding year. [15-7-111, MCA](#).

Classification and Appraisal Notice

The department must mail a classification and appraisal notice to each property owner in the first year of the two-year appraisal cycle and when any of the following changes occur:

1. a change in ownership
2. a change in classification
3. a change in assessed value, unless due to an appeal decision

4. an addition or subtraction of personal property affixed to the land-

These notices are mailed to the property owner. Generally, this is the person or entity that owned the property on January 1st of that tax year. If the ownership changed, and the department has processed this ownership change before the notices are printed, the notice will be sent to the current owners. [15-7-102, MCA](#).

Application for Agricultural Classification

Property owners may apply for agricultural classification of their land by submitting an application to the department by March 1. [ARM 42.20.620](#).

Addendum Appendix A

Agricultural Property Valuation Laws

Below are the statutes that the department follows in appraising agricultural properties:

<u>15-1-101, MCA</u>	<u>Definitions</u>
<u>15-1-201, MCA</u>	<u>Administration of revenue laws</u>
<u>15-6-133, MCA</u>	<u>Class three property -- description -- taxable percentage</u>
<u>15-6-134, MCA</u>	<u>Class four property -- description -- taxable percentage</u>
<u>15-6-201, MCA</u>	<u>Governmental, charitable, and educational categories -- exempt property</u>
<u>15-6-207, MCA</u>	<u>Agricultural producer exemptions -- products -- unused beet equipment -- low value buildings, implements, and machinery</u>
<u>15-7-101, MCA</u>	<u>Classification and appraisal -- duties of department of revenue</u>
<u>15-7-102, MCA</u>	<u>Notice of classification, market value, and taxable value to owners -- appeals</u>
<u>15-7-103, MCA</u>	<u>Classification and appraisal -- general and uniform methods</u>
<u>15-7-107, MCA</u>	<u>Certification required</u>
<u>15-7-108, MCA</u>	<u>Land split</u>
<u>15-7-111, MCA</u>	<u>Periodic reappraisal of certain taxable property</u>
<u>15-7-112, MCA</u>	<u>Equalization of valuations</u>
<u>15-7-201, MCA</u>	<u>Legislative intent -- value of agricultural property</u>
<u>15-7-202, MCA</u>	<u>Eligibility of land for valuation as agricultural</u>
<u>15-7-203, MCA</u>	<u>Agricultural uses only considered in valuation</u>
<u>15-7-206, MCA</u>	<u>Improvements on agricultural land</u>
<u>15-7-207, MCA</u>	<u>Continuance of valuation as agricultural land</u>
<u>15-7-208, MCA</u>	<u>Reclassification by department</u>
<u>15-7-210, MCA</u>	<u>Tax on change of use of part of tract</u>
<u>15-7-212, MCA</u>	<u>Tract crossing county line -- whole</u>
<u>15-8-111, MCA</u>	<u>Assessment -- market value standard -- exceptions</u>
<u>15-8-201, MCA</u>	<u>General assessment day</u>
<u>15-8-307, MCA</u>	<u>Land assessment</u>
<u>76-6-208, MCA</u>	<u>Taxation of property subject to conservation easement</u>

Agricultural Property Valuation Administrative Rules

The department follows these rules in appraising agricultural properties:

- [ARM 42.20.156](#) Land Classification Change Criteria
- [ARM 42.20.301](#) Application for Classification as Nonproductive, Patented Mining Claim
- [ARM 42.20.302](#) Definitions (*mining claims*)
- [ARM 42.20.303](#) Criteria for Valuation as Mining Claim
- [ARM 42.20.304](#) Additional Restrictions That Curtail Preferential Treatment
- [ARM 42.20.305](#) Valuation of Acreage Beneath Improvements on Eligible Mining Claims
- [ARM 42.20.307](#) Valuation of Eligible Mining Claim Land
- [ARM 42.20.601](#) Definitions
- [ARM 42.20.602](#) Steps in Determining the Classification of Agricultural Land
- [ARM 42.20.603](#) Valuation of Agricultural Land That Does Not Have A Published Soil Survey
- [ARM 42.20.604](#) Steps in Determining the Productivity of Agricultural Land
- [ARM 42.20.610](#) Classification of Easements on Agricultural Land
- [ARM 42.20.620](#) Application and Classification Requirements for Agricultural Land Totaling Less Than 160 Acres
- [ARM 42.20.640](#) Classification of Land 160 Acres or Larger in Size
- [ARM 42.20.645](#) Classification and Assessment of Those Portions of Any Agricultural, Nonqualified Agricultural, or Forest Land Parcels That Are Residential, Commercial, or Industrial Sites
- [ARM 42.20.650](#) Valuation of Nonqualified agricultural land from 20 to 160 acres
- [ARM 42.20.655](#) Classification and Valuation of One-Acre of Land Beneath Residences Located on Agricultural Land and Nonqualified Agricultural Land
- [ARM 42.20.675](#) Irrigated Agricultural Farm Land Valuation
- [ARM 42.20.676](#) Non-Irrigated Agricultural Land Valuation
- [ARM 42.20.681](#) Agricultural Commodity Prices and Values
- [ARM 42.20.682](#) Family Farm Requirements for Agricultural Land Classification
- [ARM 42.20.683](#) Specialty and Unique Crops; Additional Requirements for Agricultural Land Classification

Appendix B

(the department proposes transfer addendum in current manual to appendix B)

2021-2022 2023-2024

Examples of the Agricultural Land Productivity Valuation Formula

Per 15-7-201, MCA the formula used to determine the per-acre value of agricultural land is $V=I/R$ where:

V = productivity per-acre value of agricultural land

I = per-acre net income associated with agricultural use¹

R = capitalization rate. The rate converts an on-going income stream into value; the rate is 6.4%

Summer Fallow Farm land

Avg. price for spring wheat = ~~\$6.16~~ 5.96/bu.

Productivity = 23 bu/~~ac~~ Ac

Gross Income/ac. = ~~\$6.16~~ 5.96 * 23 bu/~~ac~~ Ac = ~~\$141.68~~ 137.08/ac Ac

Net Income = ~~\$141.68~~ 137.08 * 0.125 = ~~\$17.71~~ 17.14

~~\$17.71~~ 17.14/.064 = ~~\$276.72~~ 267.73 Productivity Value/acre

Non-Irrigated Hay land

Avg. price for alfalfa = ~~\$105.80~~ 111.30/ton

Productivity = .71 tons/~~ac~~ Ac

Gross Income/ac. = ~~\$105.80~~ 111.30/ton * .71 tons/~~ac~~ Ac = ~~\$75.42~~ 79.02/ac Ac

Net Income = ~~\$75.42~~ 79.02 * .25 = ~~\$18.78~~ 19.76/ac Ac

~~\$18.78~~ 19.76/.064 = ~~\$293.44~~ 308.68 Productivity Value/acre

Grazing Land

Avg. private grazing lease = ~~\$22.49~~ 23.50/aum

Operating Expense/aum = ~~\$22.49~~ 23.50 * .25 = ~~\$5.62~~ 5.88/aum

Adjusted Gross Income/aum = ~~\$22.49~~ 23.50 - ~~\$5.62~~ 5.88 = ~~\$16.87~~ 17.62/aum

Statewide Average Productivity = ~~.21~~ .20 aum/~~ac~~ Ac

Net Income/ac. = ~~\$16.87~~ 17.62/aum * ~~.21~~ .20 aum/~~ac~~ Ac = ~~\$3.54~~ 3.52/ac Ac

~~\$3.54~~ 3.52/.064 = ~~\$55.35~~ 55.08 Productivity Value/acre

¹ A crop share approach is used to determine the net income attributable to agricultural production. In a crop share approach, a percentage of the income from production (the share) is attributed to the landlord (owner) of the land. The remaining percentage is considered the tenant's share and includes expenses of production.

Irrigated Land

Avg. price for alfalfa	= \$405.80 <u>111.30</u> /ton
Productivity	= 3 tons/æ Ac
Water cost	= \$50.00/æ Ac
Gross Income/ac. = \$405.80 <u>111.30</u> * 3 tons/æ Ac	= \$347.40 <u>333.90</u> /æ Ac
Net Income/ac = \$347.40 <u>333.90</u> * .25	= \$79.35 <u>83.48</u> /æ Ac
\$79.35 <u>83.48</u> – Water Cost (\$50.00)	= \$29.35 <u>33.48</u> /æ Ac
\$29.35 <u>33.48</u>/.064	= <u>\$523.04</u> Productivity Value/acre (calculated)
	= \$458.59 <u>535.47</u>² <u>Productivity Value/acre (minimum value)</u>

CC Farm land

Avg. price for spring wheat	= \$6.46 <u>5.96</u> /bu
Productivity	= 23 bu/æ Ac
Income/ac. = \$6.46 <u>5.96</u> * 23 bu/æ Ac	= \$144.68 <u>137.08</u> /Ac
Net Income = \$144.68 <u>137.08</u> * .25	= \$35.42 <u>34.27</u> /Ac
\$35.42 <u>34.27</u>/.064	= <u>\$553.44</u> <u>535.47</u> Productivity Value/acre

² Based on Legislative recommendations contained in ~~HB658~~ and 15-7-201(7) (f) MCA, the minimum value of irrigated land is established at ~~\$552.99~~ 535.47 per acre. When the valuation formula calculates a value that is less than ~~\$552.99~~ 535.47, the minimum value is used. In the example the value of the irrigated land would be ~~\$552.99~~ 535.47 and not the calculated value. The minimum value is determined based on the statewide average spring wheat production (23 bu/æAc) and the CC Farmland crop share formula.